

NEK SERIES

Indoor innovative LED display for permanent installation

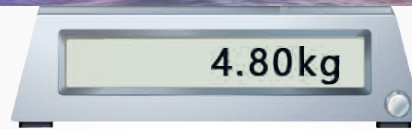

Ultra thin&light panel



Cabinet weight: 4.8 kg

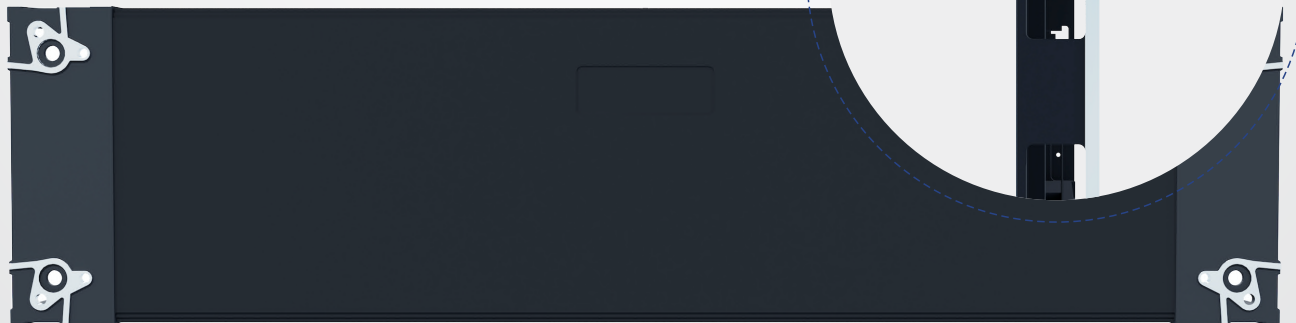
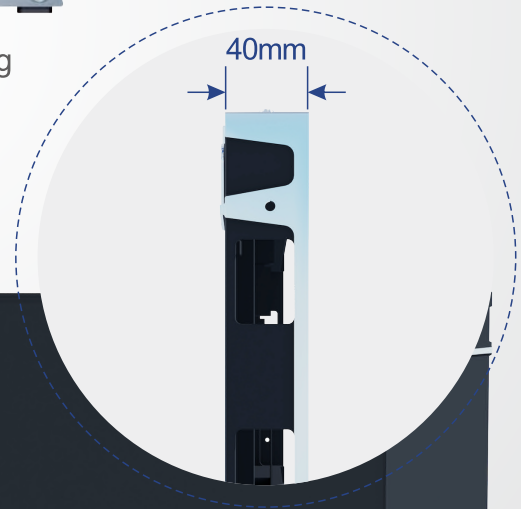

Cabinet thickness: 40mm

Easy flexible panel size made by die casting plus aluminum profile

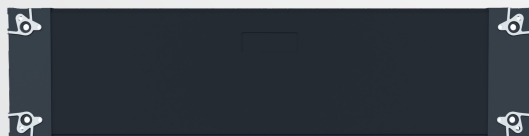

1000mmx250mm

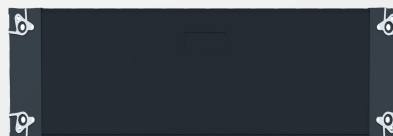

750mmx250mm

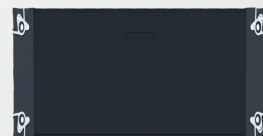

500mmx250mm

Perfect gap for 90 degree corner

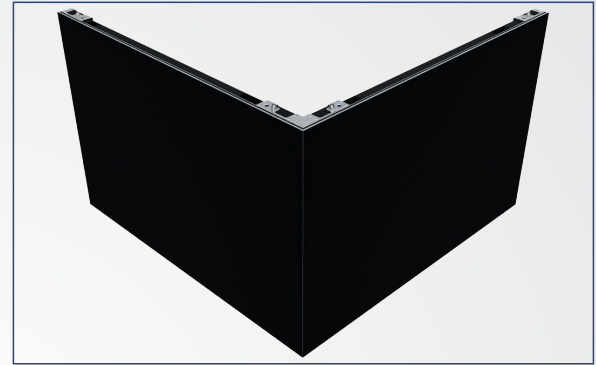
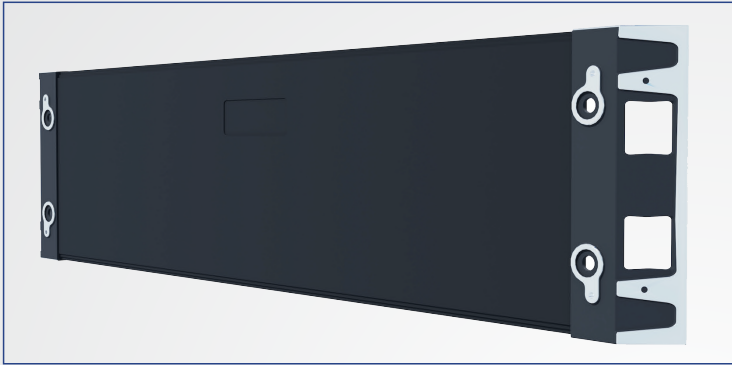

Easy full front maintenance and installation

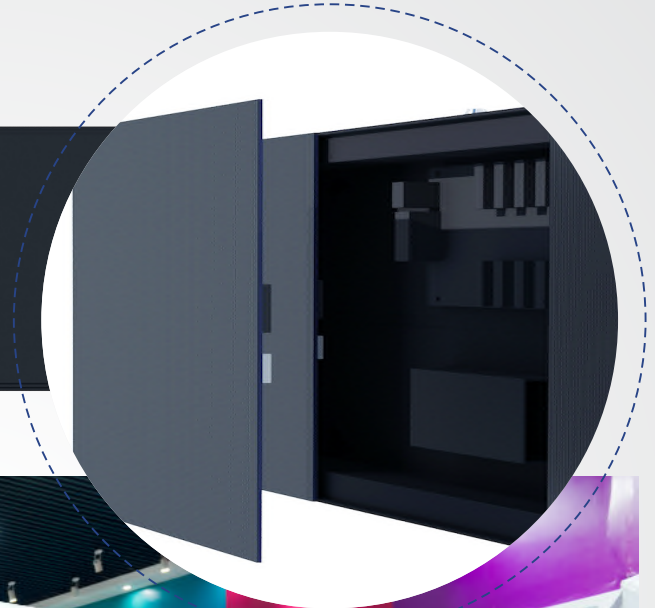
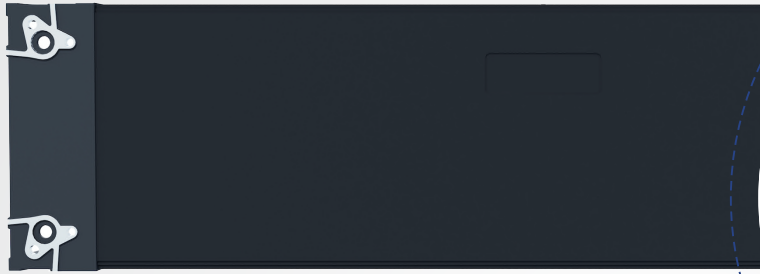

Applications



Applications



Specifications

Parameters	P1.953	P2.5
SMD configuration	3 in 1	3 in 1
LED type	SMD 1515	SMD 1515
Brightness	≥ 800 nit	≥ 1000 nit
Grey scale	14-16 bit	14-16 bit
Refresh rate	3840 hz	3840 hz
Pixel density (dot/m ²)	262144	160000
Contrast ratio	5000:1	5000:1
Panel size (mm)	1000mm/750mm/500mm*250mm	1000mm/750mm/500mm*250mm
Module size (mm)	250*250	250*250
Panel weight (kg)	4.8	4.8
Panel flatness (mm)	<0.1	<0.1
Life time (hours)	≥100000	≥100000
Viewing angle (H°/V°)	160/160	160/160
Max power consumption	550 w/m ²	478 w/m ²
Avg power consumption	182 w/m ²	158 w/m ²
Operating temperature/humidity	0°C~+45°C/10-93%RH	0°C~+45°C/10-93%RH
Storage temperature/humidity	-10°C~+55°C/10-93%RH	-10°C~+55°C/10-93%RH

